

Lussari 1600 Back to Wall

LU4-N-SW-NO / LU4M-N-SM-NO

Top view

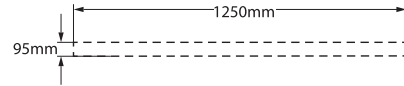
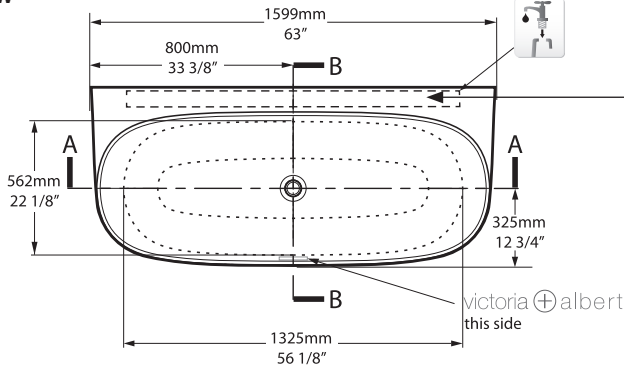

Tap holes can be drilled by installer
 Armaturenlöcher können leicht vom Installateur gebohrt werden
 Les trous de robinetterie peuvent être percés par l'installateur
 Pueden ser perforados por el instalador
 I fori per rubinetti possono essere perforati dall'installatore

Side view

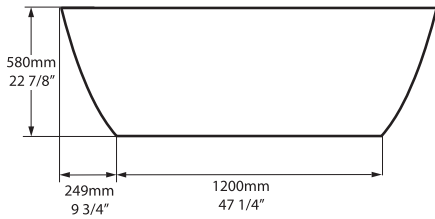

Front view

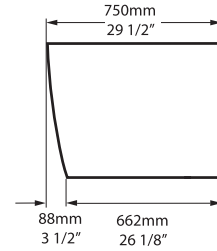

Section AA

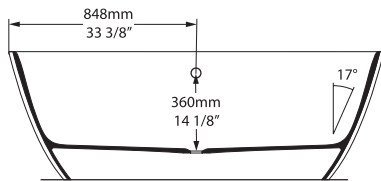

Section BB

Shown with K60/61 Waste Kit

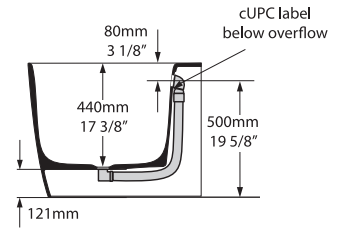

rich in Volcanic Limestone™

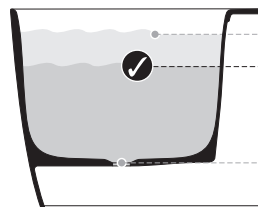

BV-2.1_0085

346	266 ltr
231	151 ltr
80	0 ltr

Recommended wastes: K-12-xx / K-36-xx / K-60-xx / K-61-xx

*All measurements subject to +/-5% tolerance
 *Overflow hole can be drilled



Massachusetts Code: Pending
 cUPC listing by IAPMO: File No. Pending



Guaranteed for residential use for 25 years*
 25 Jahre Garantie bei privater Nutzung
 25 ans de garantie pour un usage domestique
 Garantía de 25 años para uso domestico
 La sicurezza garantita per uso residenziale per 25 anni



Guaranteed for commercial use for 8 years*
 8 Jahre Garantie bei gewerblicher Nutzung
 8 ans de garantie pour un usage commercial
 Garantía de 8 años para uso comercial
 La sicurezza garantita per uso commerciale per 8 anni

* QUARRYCAST™ white products only.
 Paint finish exterior guaranteed for 2 years.
 * Nur auf weisse QUARRYCAST™ Produkte.
 Auf Aussenlackierung gibt es 2 Jahre Garantie.
 * Uniquement pour les produits en QUARRYCAST™ blanc.
 Pour les finitions extérieures peintes la garantie est de 2 ans.
 * Solo sobre productos en QUARRYCAST™ blanco.
 Acabados de pintura exterior tienen una garantía de 2 años.
 * Solo per prodotti bianchi in QUARRYCAST™.
 Finitura esteriore dipinta garantita per due anni.